

ST80050



Miscelatore monocomando per lavello, bocca girevole, aeratore 22x1, cartuccia ceramica portata 12 l/min. Comando touch per funzione chiudi scarico con tecnologia Guglielmi. Elettronica marchio CE. Flex di alimentazione softpex 3/8". Fissaggio con sistema rapido. Compatibile con lavello ad una vasca. Da abbinare con scarico 3" 1/2 automatico.

Single lever sink mixer, swivel spout, 22x1 aerator, ceramic cartridge 12 l/min flow rate. Touch command for drainage self-closing function with Guglielmi technology. CE branded electronic. 3/8" connection flexible hoses of softpex. Fixing with rapid system. Compatible with one bowl sink. To be combined with 3" 1/2 automatic drain.

CARATTERISTICHE FEATURES



CERTIFICAZIONI PRODOTTO PRODUCT APPROVALS

L'articolo può disporre di alcune di queste certificazioni. The article may have some of these approvals.

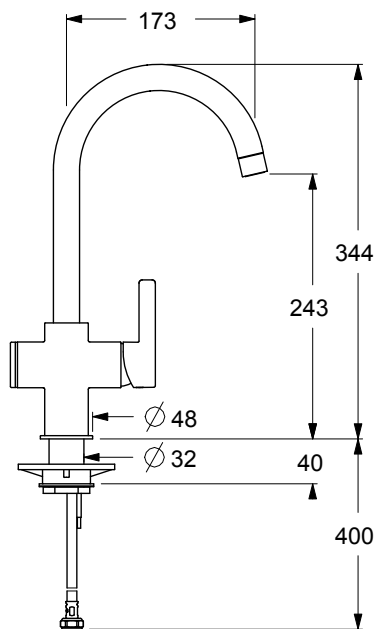

FORO UTILE HOLE WIDTH Ø35

IMBALLI E RICICLABILITÀ PACKAGING AND RECYCLING

SCATOLA BOX	VOLUME VOLUME	TARA TARE	PESO LORDO GROSS WEIGHT
11 x 36,5 x 78 cm	0,031 m <sup>3</sup>	0,95 kg	4,66 kg
COLLO MC	VOLUME VOLUME	TARA TARE	N° SCATOLE PER COLLO N° BOXES FOR MC
38 x 80 x 40 cm	0,122 m <sup>3</sup>	1,2 kg	3
PLASTICA PLASTIC	CARTA PAPER	PALLET PALLET	N° COLLI PER PALLET N° MC FOR PALLET
0,522 kg	0,99 kg	9,6 kg	9

DIAGRAMMA DI PORTATA FLOW RATE DIAGRAM

Test eseguito secondo le norme europee EN 817 - EN 200. Portata calcolata con l'impiego di aeratori certificati.

Test carried out according to the European standards EN 817 - EN 200. Flow rate calculated by the application of certified aerators.

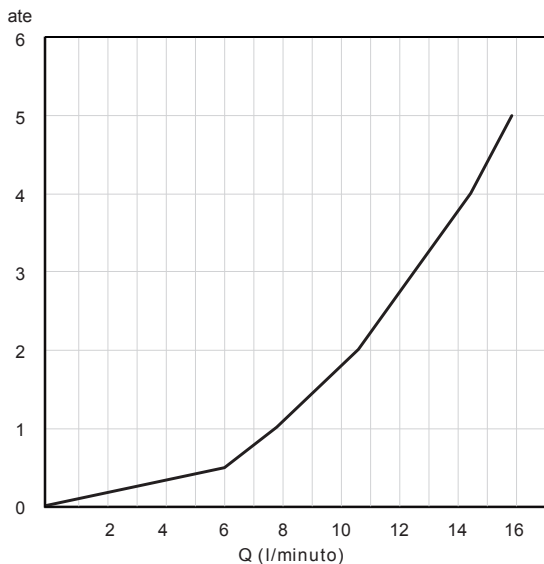

ate	1	2	3	4	5
Q (l/min)	7,9	10,5	12,3	14,2	15,8